

# User Guide – ActiveCore Freezer

Thank you for purchasing a SKOPE refrigeration product.

This guide covers both self-contained cabinets and remote cabinets (which are connected to a separate condensing unit).

## Safety

Always observe safety precautions when using any electrical appliance. Read these instructions carefully and retain them for future reference.

### WARNING

- Ensure the appliance is disconnected from the power supply before performing any cleaning or maintenance.
- Do not cover the grilles or block the entry or exhaust of airflow by placing objects up against the refrigeration unit.
- Should manual defrosting be necessary, turn off the refrigeration system and allow the ice to melt by air circulation. Collect ice and water during defrost to prevent a slip hazard. Do not use mechanical methods to remove ice, as this may damage the refrigeration circuit.
- Do not use any electrical devices or appliances inside the food storage compartment.

This appliance is not intended for use by persons (including children) with reduced physical, sensory or mental capabilities, or lack of experience and knowledge, unless they have been given supervision or instruction concerning use of the appliance by a person responsible for their safety. Children should be supervised to ensure that they do not play with the appliance.

- Do not use this appliance for other than its intended use.
- Do not insert fingers/foreign objects into any holes.
- Only use this appliance with the voltage specified on the cabinet rating label.
- Ensure the appliance has adequate ventilation as this is essential to economical, high performance.
- Be careful not to touch moving parts and hot surfaces.
- For your own safety and that of others, ensure that all electrical work is done by authorised personnel.
- If the power supply flexible cord becomes damaged, it must be replaced by an authorised service agent or similarly qualified person in order to avoid a hazard.
- If installing or removing the refrigeration unit, refer to the Installation Guidelines below, and observe all necessary safety precautions.
- The appliance is not designed to be stable while in motion. Use extreme caution when moving or transporting it.
- Do not store explosive substances such as aerosol cans with a flammable propellant in this appliance.
- If the cabinet is to be scrapped, ensure the cabinet is unplugged from the power supply and cut off the mains flex close to the back of the cabinet. Be mindful of the risk of animals or children becoming trapped in the appliance – either remove or secure doors if necessary.
- Refrigerant must be removed by a qualified service person and the cabinet recycled/disposed of in accordance with local regulations.

### WARNING

- Ensure the doors are held shut when moving or transporting the cabinet.

This cabinet is designed to operate within a specific climatic class environment.

See the cabinet rating label inside the cabinet for climate class number.

Climate class	Ambient temperature	Relative humidity
3	25°C	60%
4	30°C	55%
5	40°C	40%
7 (tropical)	35°C	75%

The cabinet includes relevant hazard symbols that may be associated with the cabinet. Refer to the information below for symbol description.



### WARNING

The refrigeration system contains flammable R290 refrigerant. Do not tamper with it. The refrigeration system must only be serviced by qualified personnel.

Flammable refrigerant warning is not applicable to remote cabinets.

## Service and Support

We know you will get years of satisfaction from your new SKOPE product when you follow a few simple preventative maintenance guidelines. Helpful information is available on the SKOPE website: [www.skope.com/serviceandsupport](http://www.skope.com/serviceandsupport)

## Installation Guidelines

Ensure you consider and meet the installation guidelines.

If refrigeration cartridges must be removed (e.g. to transport the cabinet through a low clearance doorway), refer to the Unit Removal Instructions on the back of the cabinet. Contact SKOPE if they are missing.

Note that cabinets with remote condensing units cannot be moved after they have been installed. They are fixed in place to refrigeration, electrical, and condensate drain pipework. Contact a refrigeration service technician if you need to move the cabinet.

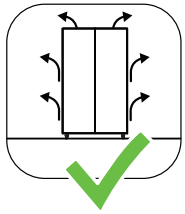

### Ventilation

Ensure all ventilation requirements below are met.

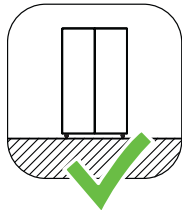

### Surface

The installation surface must be able to support the loaded cabinet.

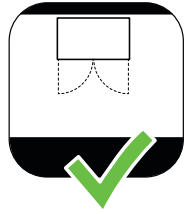

### Door Opening

Allow adequate space for the door/s to open and close properly.



### Climate Class

The cabinet must be installed in an environment within its climate class.

### Rating Label

The climate class is stated on the cabinet rating label inside the cabinet, and specified on the back page of this user guide.

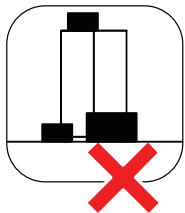

### Blocking Ventilation

Do not store boxes or items in front or on top of the cabinet.

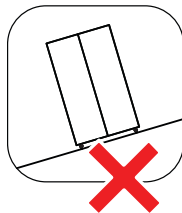

### Uneven Surface

Do not install the cabinet on an uneven surface.

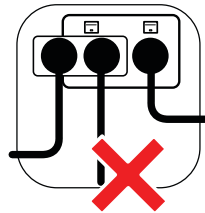

### Power Supply

Do not overload the power supply.

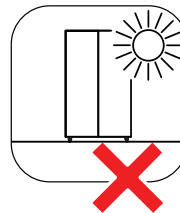

### Sunlight

Do not install the cabinet in direct sunlight.

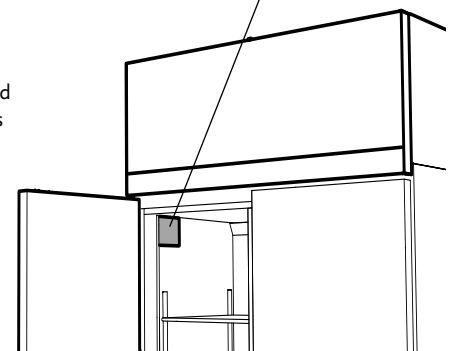

## Ventilation Requirements

This cabinet must have the following ventilation clearances at all times.

In certain climatic conditions, condensation may form on the back of the cabinet. If this is observed, ensure air circulation between the cabinet and the wall by sticking two of the enclosed self-adhesive blocks to the back of the cabinet, as shown.

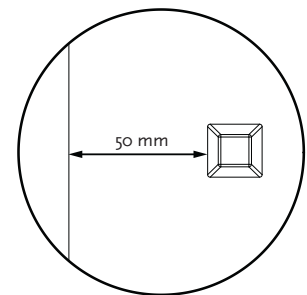
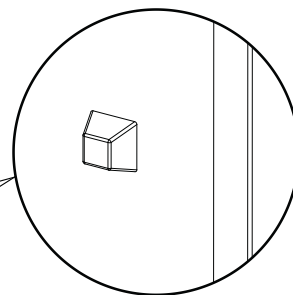
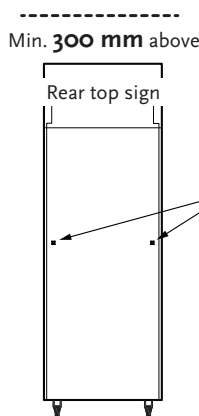
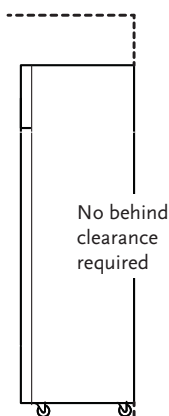
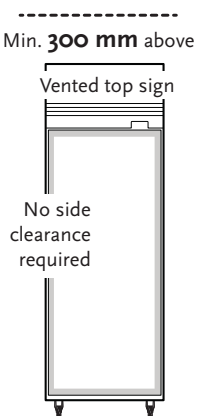

### Adhesive Blocks

If required use two adhesive blocks on the rear of the cabinet. Position the blocks on the left and right hand sides of the cabinet, approximately half way up and 50 mm from the cabinet edge.

No below clearance required

## Shelves

The wire shelves sit on shelf clips which twist onto the shelf support strips inside the cabinet. The shelves may be positioned at different heights to suit various product. Use the numbers on the shelf support strips to help set the shelf clips at the same height.

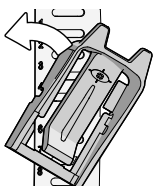

### To fit a shelf clip

Twist anticlockwise onto the shelf support strip.

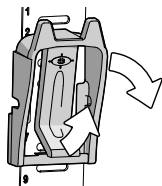

### To remove a shelf clip

Pull the centre tab up and twist off clockwise.



### To adjust the shelf clip height

Pull the centre tab up, and slide up or down as required. Once in position, ensure it clicks into place.

## Lights

The cabinet lights have a manual on/off switch, or can be switched on and off remotely if connected to the building management system (BMS).

## Door Lock/s

The cabinet may be fitted with bracket locks or key locks, located above or below each door. Bracket locks require a lock (padlock or similar) through the brackets to lock the door. Key locks can be locked with the supplied key.

## Door Handles

The door handles may be packed inside the cabinet.

### To fit a door handle

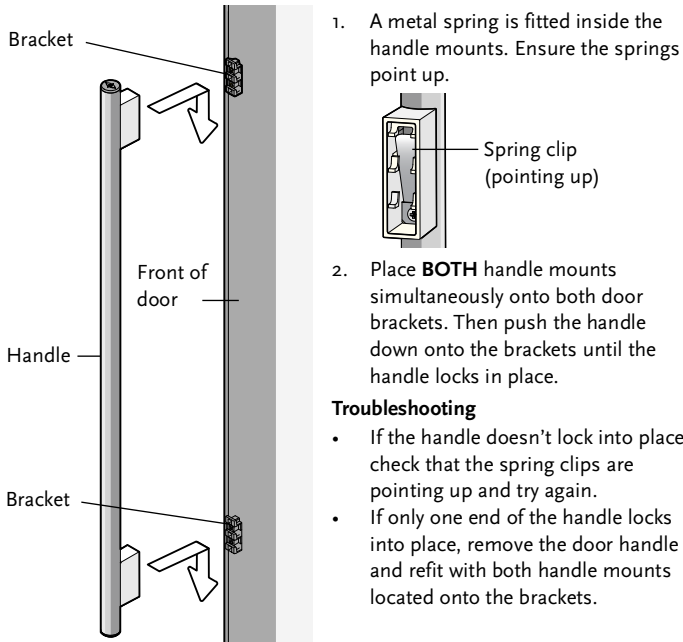

### To remove a door handle

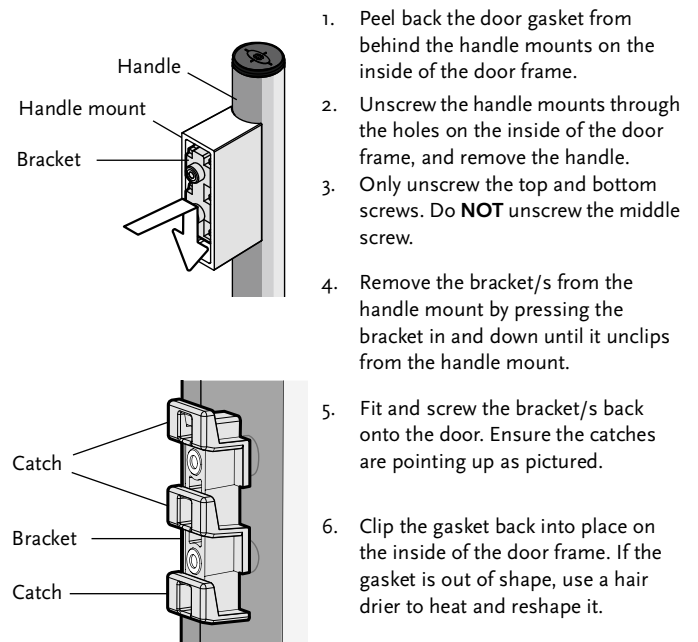

## Loading Product

Let the freezer run for 30 minutes before loading it with product for the first time. When loading the shelves with product:

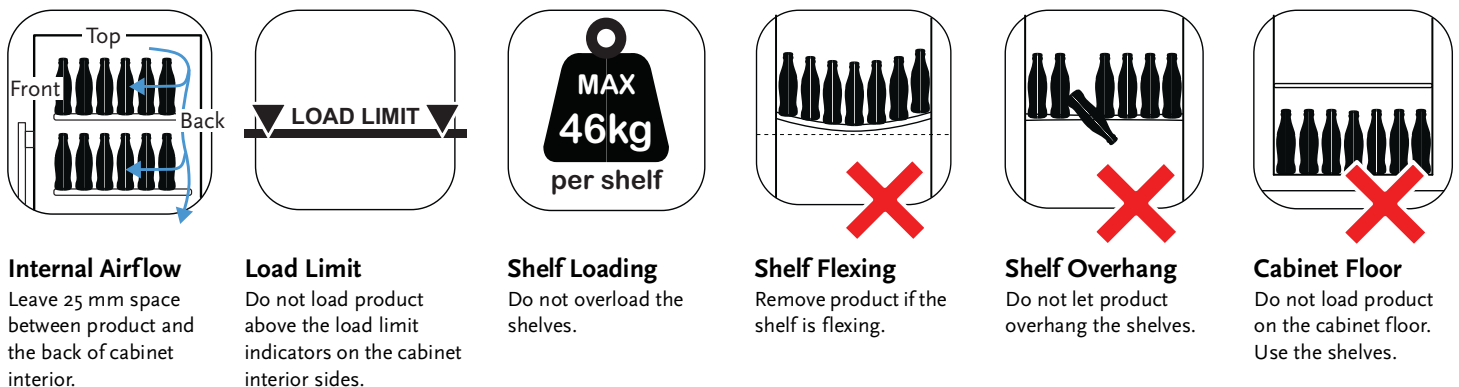

## Electronic Controller

The Dixell XR77CH electronic controller regulates the cabinet's temperature, signals alarms and captures operational information. The freezer temperature is set at the factory for storing perishable product – all shelves maintain L1 temperature range: less than -18°C (can spike up to -15°C).

The SKFT1500NZ (self-contained cabinet) has a controller for each refrigeration cartridge. Only the right hand controller is visible. The left hand controller is hidden behind the sign, and you will need a ladder to reach it.

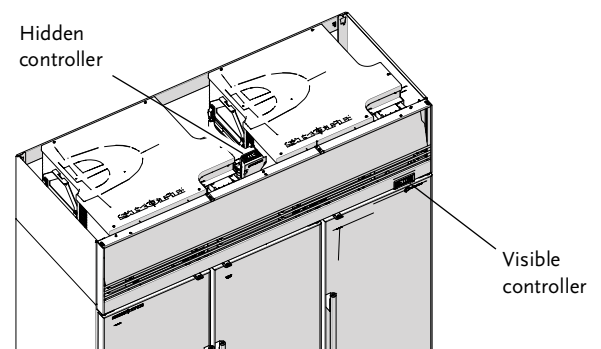

SKFT1500NZ (self-contained cabinet)

## Setpoint

If necessary, change the setpoint using the following procedure.

If changing the setpoint on the SKFT1500NZ, make sure that you adjust both controllers to have the same setpoint.

<ol style="list-style-type: none"> <li>1. Check the setpoint: <ul style="list-style-type: none"> <li>• Push and immediately release the SET button: the display will show the setpoint value.</li> <li>• Wait 5 seconds for the display to show the probe value again.</li> </ul> </li> </ol>	<ol style="list-style-type: none"> <li>3. Push the UP or DOWN arrows within 10 seconds.</li> </ol>
<ol style="list-style-type: none"> <li>2. Push the SET button for more than 2 seconds to change the setpoint value. The value of the setpoint will be displayed and the “°C” or “°F” LED will start blinking.</li> </ol>	<ol style="list-style-type: none"> <li>4. Save the new setpoint by pushing the SET button again or waiting for 10 seconds.</li> </ol>

## Real Time Clock

For the cabinet to work correctly, the Dixell controller’s real time clock must be set.

Note that the SKFT1500NZ (self-contained cabinet) has a controller for each refrigeration cartridge which are kept in sync with the real time clock. For correct defrost synchronisation the two controllers’ clocks must be set accurately. Only the right hand controller is visible. The left hand controller is hidden behind the sign, and you will need a ladder to reach it.

<ol style="list-style-type: none"> <li>1. Enter the Pr1 programming menu by pushing both SET + DOWN buttons for 3 seconds. The rtC parameter is displayed.</li> </ol>	<ol style="list-style-type: none"> <li>4. Confirm the value by pushing SET button.</li> </ol>
<ol style="list-style-type: none"> <li>2. Push the SET button to enter the real time clock menu. The Hur (hour) parameter is displayed.</li> </ol>	<ol style="list-style-type: none"> <li>5. Repeat the procedure to set the Min (minutes) and dAy (day) parameters.</li> </ol>
<ol style="list-style-type: none"> <li>3. Push the SET button and then set current hour using the UP and DOWN buttons.</li> </ol>	<ol style="list-style-type: none"> <li>6. Exit by pushing the SET + UP buttons.</li> </ol>

## Cleaning

### Regular cleaning

Ensure the cabinet is unplugged from the power supply before cleaning.

Wipe the inside and outside of the cabinet with a damp cloth, taking care to keep moisture away from electrical parts.

### Condenser coil

#### Remote cabinets

Arrange a service technician to clean the condenser annually, and check for any maintenance requirements.

#### Self-contained cabinets

**Note:** the SKFT1500NZ has two refrigeration cartridges.

The condenser coil must be kept clean. SKOPE strongly urges cleaning the condenser coil every three months.

Do **NOT** use hard or sharp tools to clean the coil as these may cause damage.

### Clean the coil

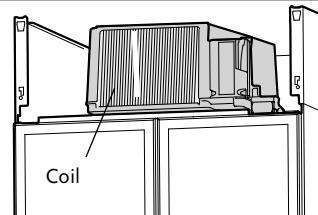
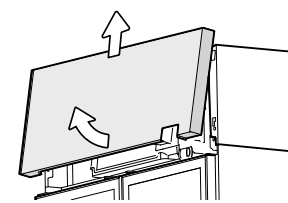
<ol style="list-style-type: none"> <li>1. Unplug the cabinet from the power supply, and unplug any lit sign panels.</li> </ol>	<ol style="list-style-type: none"> <li>3. Brush the condenser coil with a soft brush to remove any dust and fluff.</li> </ol> 
<ol style="list-style-type: none"> <li>2. Remove the front panel from the top of the cabinet.</li> </ol> <p><b>WARNING: Front panel is heavy, a two person lift is recommended.</b></p> 	<ol style="list-style-type: none"> <li>4. Refit the sign assembly and reconnect to the power supply.</li> </ol> <p><b>Important</b> When refitting, ensure the tabs on the back of the sign are located in the notches on top of the cabinet, and that the sign is pushed fully in and secure.</p> 